

TAKI 38-U/IF (LG/GM/IN)

Stainless steel 304

Base 40

TAKI 20-U/IF-IN 4973043
 TAKI 20-U/IF-LG 4973092
 TAKI 20-U/IF-GM 4973106

Weight (kilogram) 4,2

Врезной монтаж

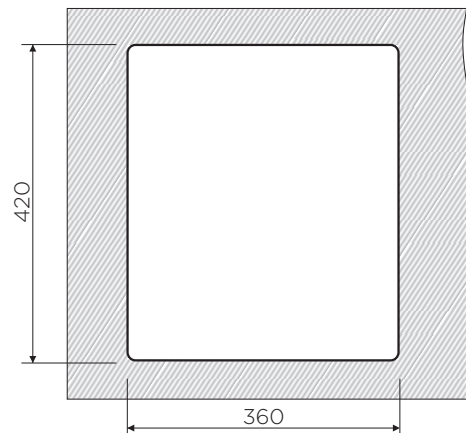
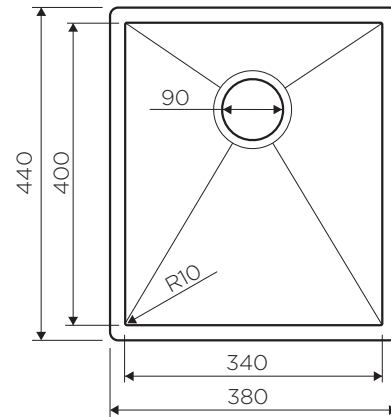
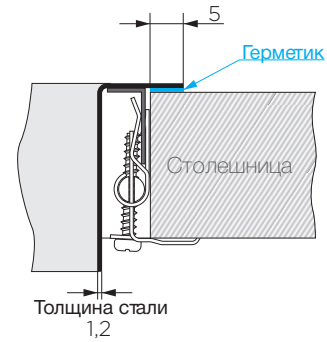
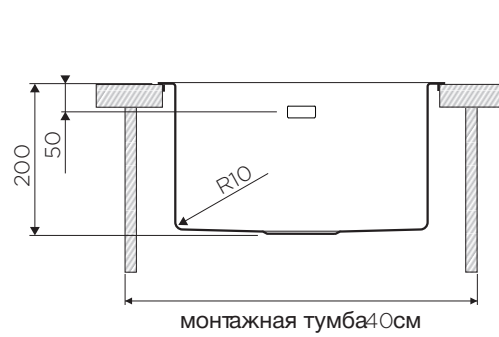

TAKI 38-U/IF (LG/GM/IN)

Stainless steel 304

Base 40

TAKI 20-U/IF-IN 4973043
TAKI 20-U/IF-LG 4973092
TAKI 20-U/IF-GM 4973106

Weight (kilogram) 4,2

Монтаж вровень со столешницей

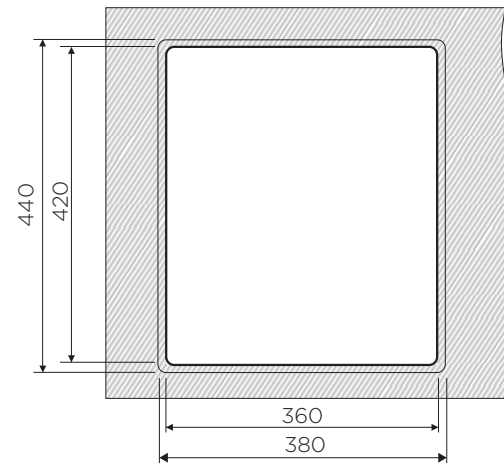
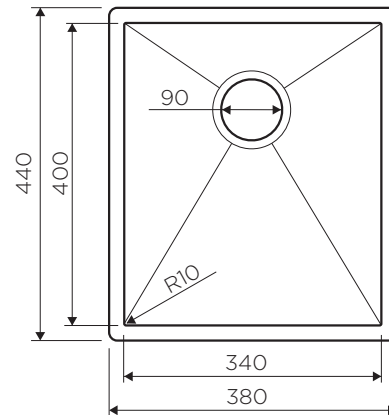
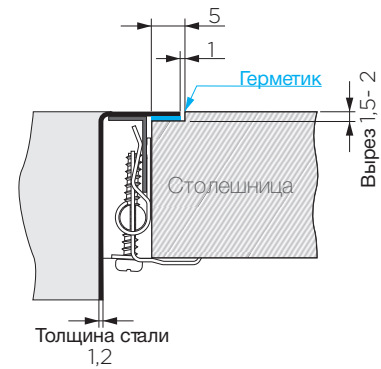
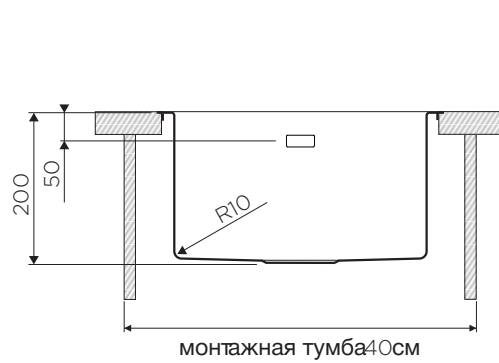

TAKI 38-U/IF (LG/GM/IN)

Stainless steel 304

Base 40

TAKI 20-U/IF-IN 4973043
TAKI 20-U/IF-LG 4973092
TAKI 20-U/IF-GM 4973106

Weight (kilogram) 4,2

Подстольный монтаж

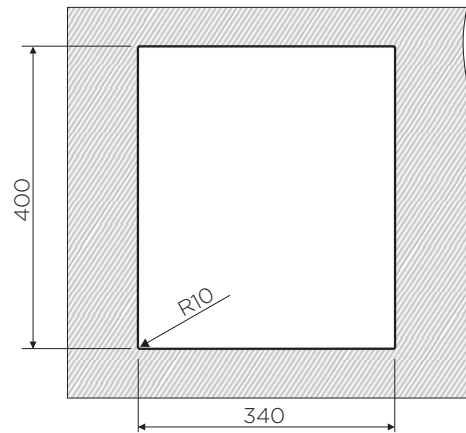
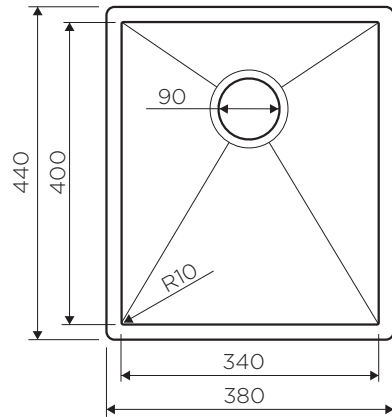
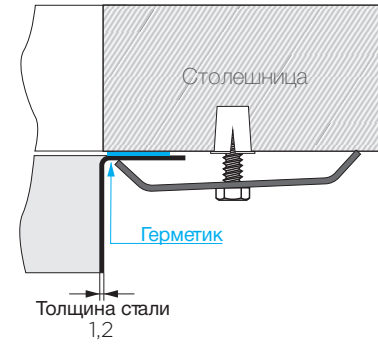
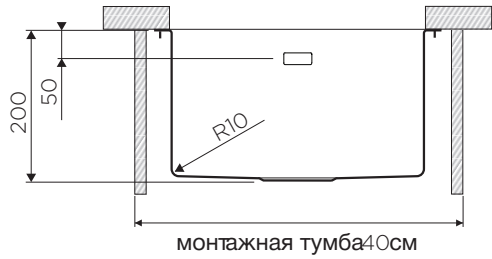

TAKI 38-U/IF (LG/GM/IN)

Stainless steel 304

Base 40

TAKI 20-U/IF-IN 4973043
TAKI 20-U/IF-LG 4973092
TAKI 20-U/IF-GM 4973106

Weight (kilogram) 4,2